



86 series 3-phase Stepping Motors



General Specifications

Step Angle Accuracy	+5% (full step, no load)
Temperature Rise	80°C Max
Ambient Temperature	-10°C -- +50°C
Insulation Resistance	100MΩ min. 500VDC
Dielectric Strength	500VAC for one minute
Shaft Radial Play	0.06 Max. (450g-load)
Shaft Axial Play	0.08 max. (450g-load)

Electrical Specifications

Model No.	Step Angle	Holding Torque	Current /phase	Inductance /phase	Resistance /phase	# of leads	Rotor Inertia	Detent Torque	Motor Weight	Motor Length L
	(°)	N.m	A	mH	Ohm		g.cm ²	N.cm	Kg	mm
863S22	1.2	2.0	5.0	2.8	0.9	6	1200	-	2.1	73
863S42	1.2	4.0	5.0	4.5	1.35	6	2500	-	3.0	105
863S68H	1.2	6.78	3.5	20	4.5	6	3300	-	3.8	127

* Above motors are our typical models, and if you need a customization motor, please contact us.

Mechanical Specifications

Dimensions are in millimeters and 1 inch=25.4mm

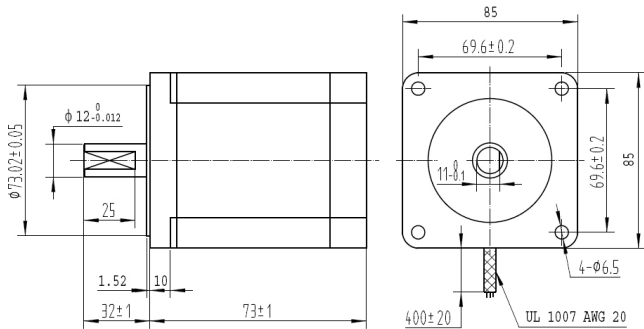

Figure 1: Mechanical specifications of 863S22

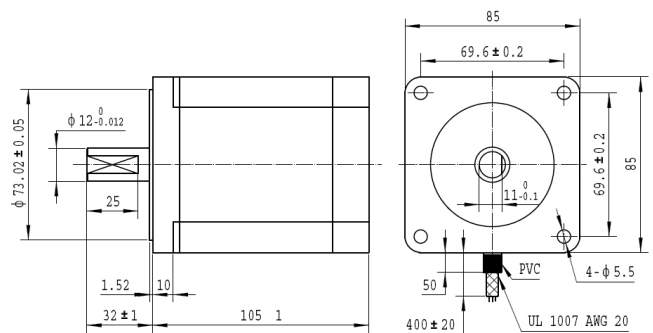

Figure 2: Mechanical specifications of 863S42

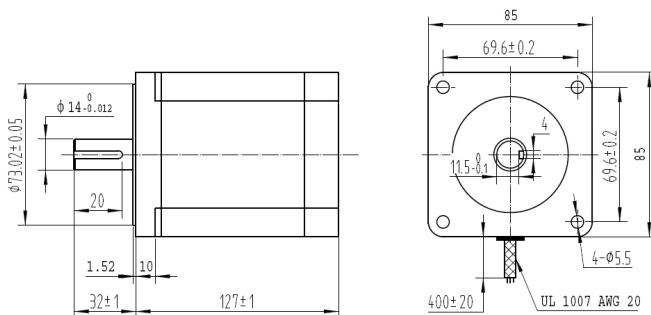

Figure 3: Mechanical specifications of 863S68H



Wiring Diagrams

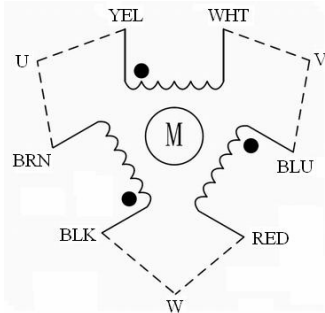

Figure 4: Wiring diagram of the 863Sxx

Speed-Torque Characteristics

Speed-torque curves show the maximum torques that can be output at a given speed. When selecting a motor, make sure the required torque falls within the particular curve.

• 863S22

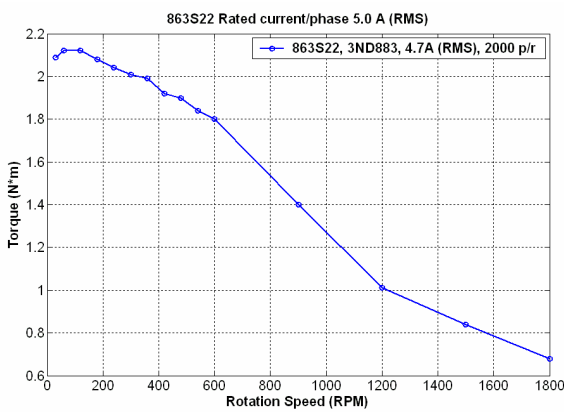

Figure 5: Speed-torque curves of the 863S22

• 863S42

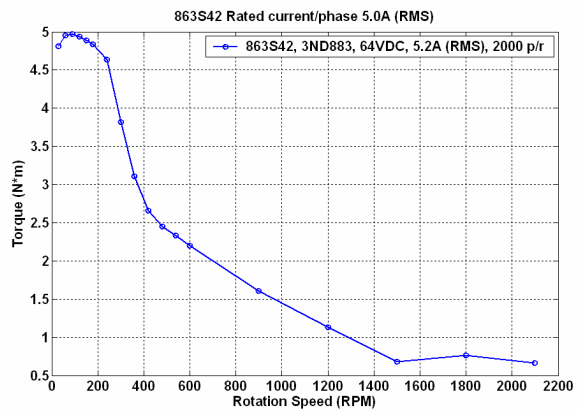

Figure 6: Speed-torque curves of the 863S42

• 863S68H

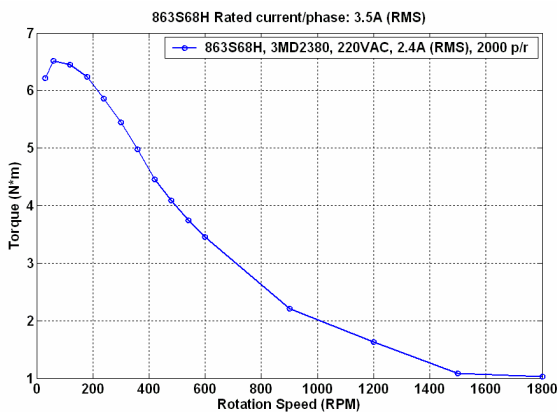

Figure 7: Speed-torque curves of the 863S68H

Remarks:



1. Title "863S22 Rated current/phase: 5.0A (RMS)" means "The rated current/phase of the 863S22 is 5.0A (RMS) ".
2. Legend "863S22, 3ND883, 64VDC, 4.7A (RMS), 2000p/r" means "This speed-torque curve of the 863S22 was done with the 3ND883 driver. The settings of the 3ND883 are 4.7A (RMS), resolution is 2000 pulses per revolution and use 64VDC power supply ".
3. The actual characteristics will vary depending on the driver used. Please use these curves only for reference purposes when selecting a motor. You must also conduct a thorough evaluation with the actual driver to be used. Please consult "Leadshine Motor and Driver Packages" for more information about this issue.